

Main technical data for an aqueous spray cleaning machine, for cleaning heights 900, 1200, 1500 and 1800 mm.

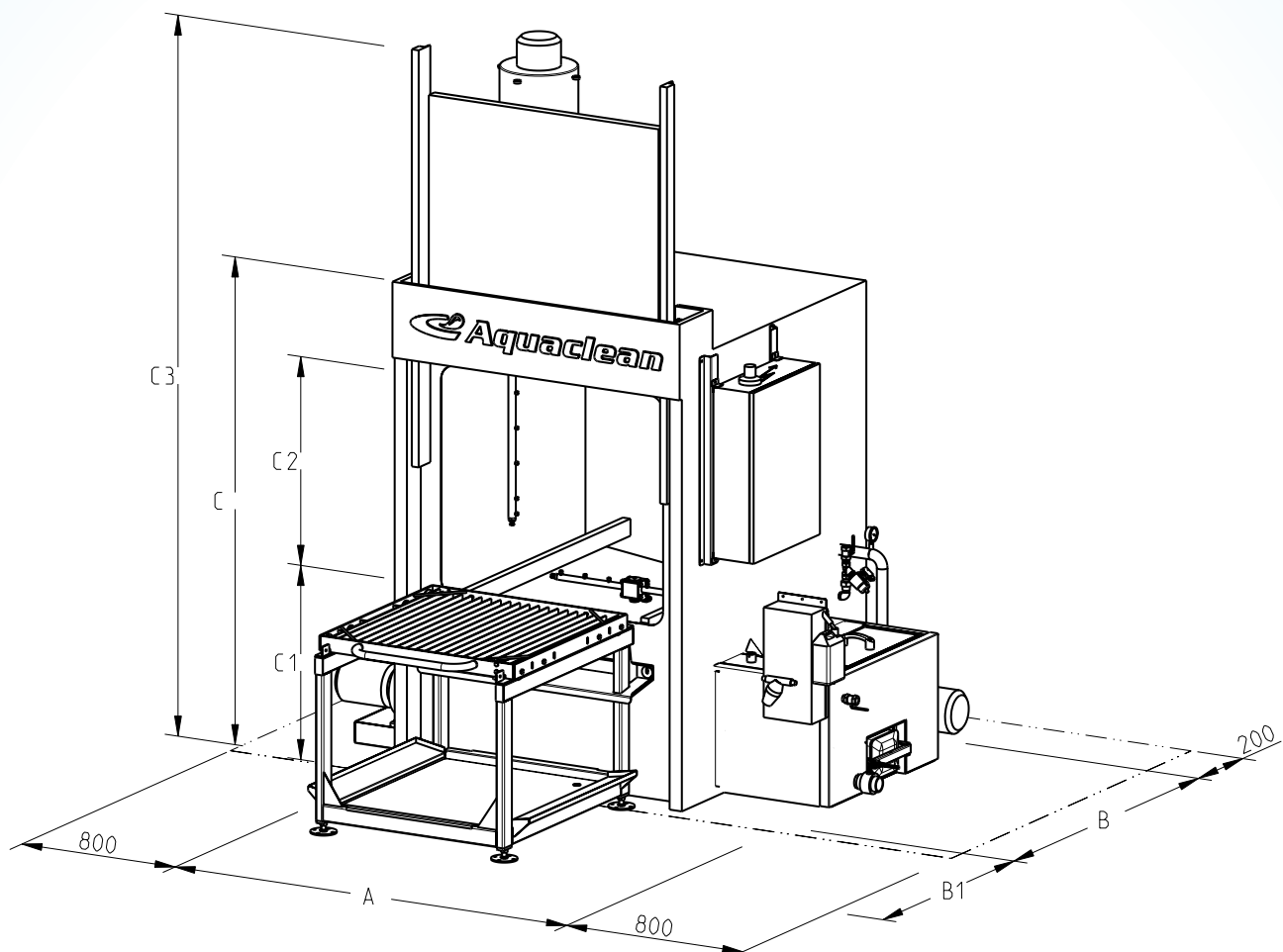

MAIN DIMENSIONS (mm)		AC-1.7LD (C2=900)	AC-1.7-C12LD (C2=1200)	AC-1.7-C15LD (C2=1500)	AC-1.7-C18LD (C2=1800)
Width	A	2650	2650	2650	2650
Depth	B	1990	1990	1990	1990
	B1	1470	1470	1470	1470
Height	C	2320	2720	3020	3320
	C1	910	910	910	910
	C2	900	1200	1500	1800
	C3	3390	3990	4590	5190
Load Carriage	L x W	1300	1300	1300	1300



TECHNICAL DATA		AC-1.7LD (C2=900)	AC-1.7-C12LD (C2=1200)	AC-1.7-C15LD (C2=1500)	AC-1.7-C18LD (C2=1800)
Tank volume	l	1200	1200	1200	1200
Heating capacity	kW	24	24	24	24
Pump flow	l/min	450	500	550	600
Pump pressure	bar	4.5	4.5	4.5	4.5
Pump motor	kW	7.5	7.5	7.5	7.5
Max. component dimensions	L x W ^{mm}	1300	1300	1300	1300
	Height ^{mm}	900	1200	1500	1800
	Diam. ^{mm}	1500	1500	1500	1500
	Weight ^{kg}	800	800	800	800
Machine weight	kg	1650	1650	1650	1650
Connection power	kW	25	25	25	25